

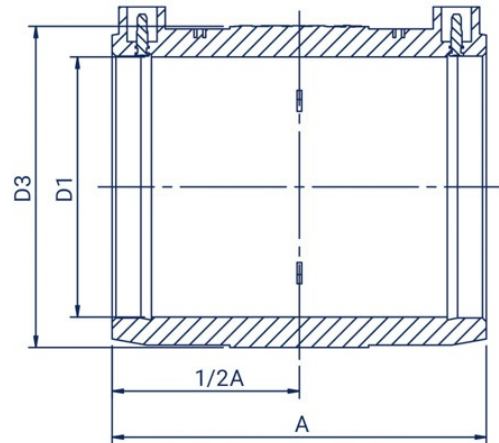

- material: PE 100-RC
- application: water and gas
- 16 bar water, 10 bar gas
- MRS - 10 MPa
- removable centre stop
- no centre stop in 355-630 mm diameters



Code	D1 (mm)	D3 (mm)	A (mm)	Quantity per parcel
ME02011	20	34.5	84	200
ME02511	25	35.5	84	200
ME03211	32	42.5	84	180
ME04011	40	52	92	150
ME05011	50	64	93	100
ME06311	63	79	114	50
ME07511	75	96.5	135	30
ME09011	90	112	148	22
ME11011	110	134	157	14
ME12511	125	152	166	18
ME14011	140	168	176	14
ME16011	160	195	180	12
ME18011	180	213	186	8
ME20011	200	241	189	6
ME22511	225	271	221	4
ME25011	250	295	224	2
ME28011	280	336	247	2
ME31511	315	379	258	2
ME35511	355	425	296	2
ME40011	400	476	303	1
ME45011	450	537	320	1



Code	D1 (mm)	D3 (mm)	A (mm)	Quantity per parcel
ME50011	500	600	378	1
ME56011	560	690	388	1
ME63011	630	750	396	1